



Vaportite Adjustalume Series



*Not all product variations listed on this page are DLC qualified. Visit www.designlights.org/search to confirm qualification



Description

The Litelume LED Vaportite (LL-VT) Adjustalume Series is a suspended or surface mounted vapor proof luminaire designed for retrofit or new construction. Applications include parking garage, stairwell lighting, car washes, food processing, commercial and industrial with applicable building and safety codes. Featuring 3 level lumen output and 3 color adjustable CCT, allowing for customized energy savings and comfortability. High Power factor .95 and low THD.

Fixture Information

Size:	20W/25W/30W/34W/38W/45W/ 65W/75W/90W
Housing:	High quality ABS
Lens:	Impact resistant polycarbonate
Colors:	Standard: Grey
Mountings:	Standard: Surface Mount, Suspended Mount
Accessories:	Emergency Back-up Battery
Sensor:	Standard: No sensor Optional: Integrated Microwave Motion sensor
Dimming:	0-10V
Operating Temperature:	-22° F to 113° F
Power Factor:	.95
CRI:	83
Voltage:	Standard: 120-277V Optional: 480v
Warranty:	10-Year Limited Warranty

Performance Data

Lumen Output:

2,872 to 12,364 lm

Lumens Per Watt (typical):

142 to 147 lm/W

CCT:

3500K
4000K
5000K

Lifespan:

up to 100,000 hrs

Ratings & Certificates

UL Listed for Wet Locations
IP66 rated





Dimension

Item	Height	Length	Width	Weight
2'	3.5"	24.8"	5.0"	3.40 lbs
4'	3.5"	49.8"	5.0"	5.86 lbs
8'	3.5"	94.5"	5.0"	11.24 lbs

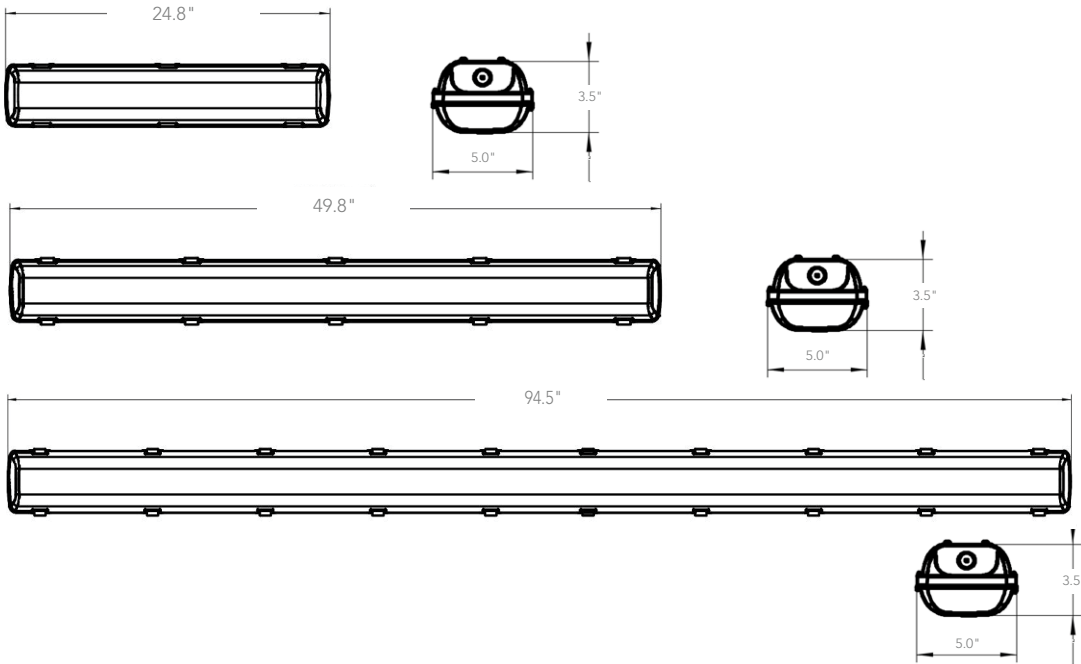

Accessories

ANT-3C	RC100	EM8, EM15, EM20

2' (30W 3500K)

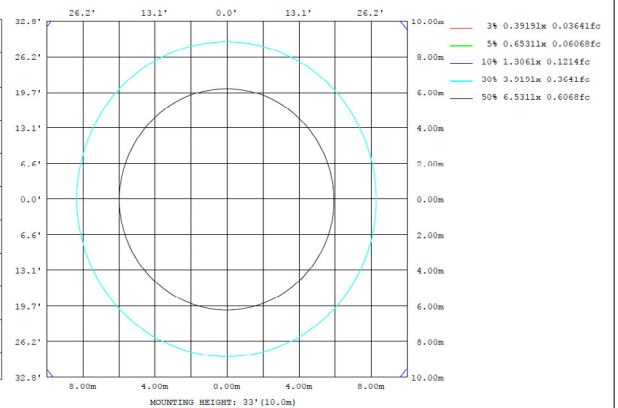
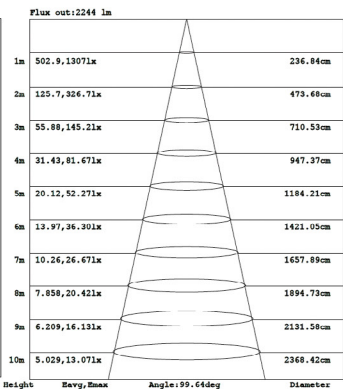
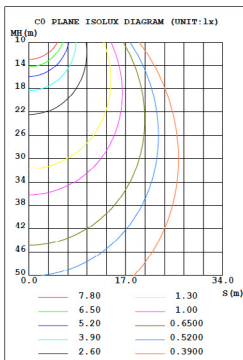
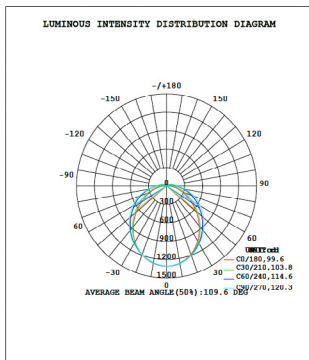



4' (45W 3500K)

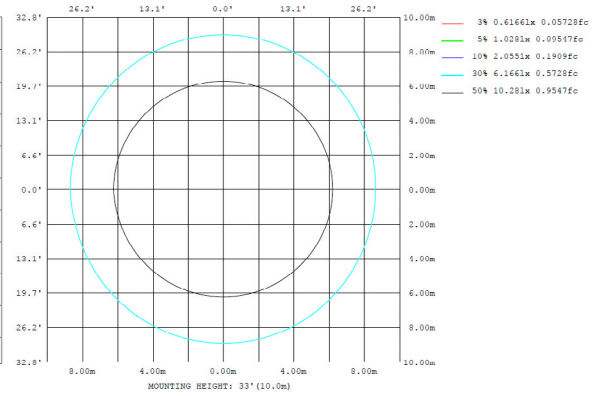
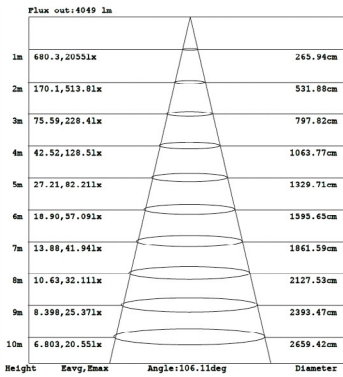
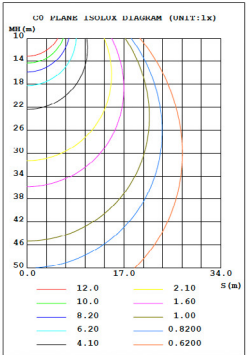
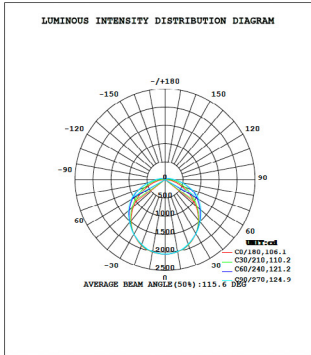

8' (90W 3500K)

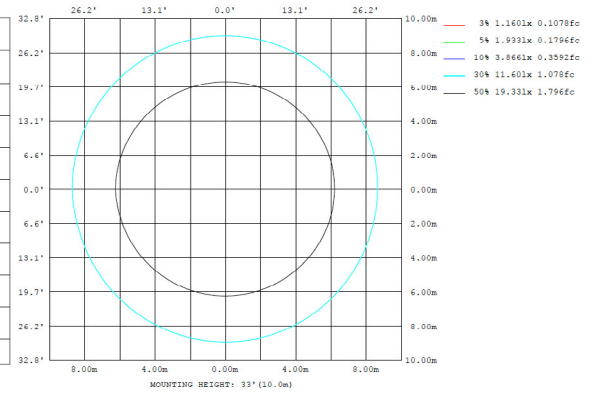
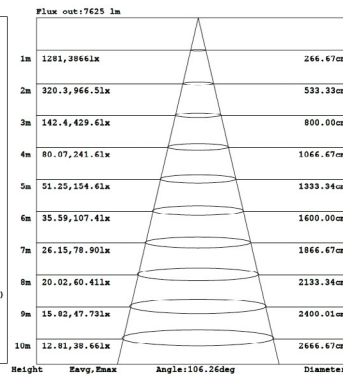
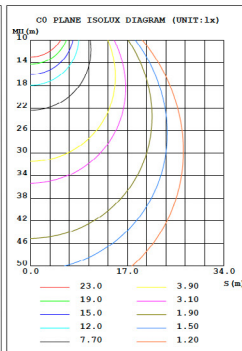
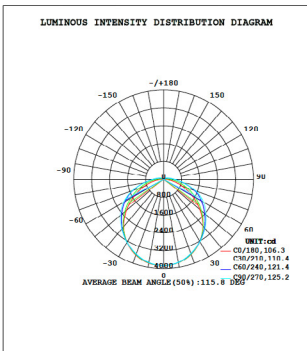



Project Name	
Catalog #	
Job Type	
Prepared By	
Notes	

Fixture Ordering Information

Part #	Wattage	Lumens	Kelvin	Voltage
LL-VT2-[20][25][30]-3CCT-UNV	20W 25W 30W	2872/3454/4021	3500K 4000K 5000K	120-277
LL-VT4-[34][38][45]-3CCT-UNV	34W 38W 45W	4941/5423/6494	3500K 4000K 5000K	120-277
LL-VT8-[65][75][90]-3CCT-UNV	65W 75W 90W	9295/10500/12364	3500K 4000K 5000K	120-277

Accessories Ordering Information

Part #	Description
ANT-3C	Sharkward 10-14V DC 0-10C Microwave Motion Sensor
ANT-7D-BLE-SR	Sharkward Silvair 10-14V DC 0-10V Bluetooth Microwave Sensor
ANT-7D-BLE-GE	Homewell GEBC 10-14V DC 0-10V Bluetooth Microwave Sensor
RC100	Remote Control 100
EM8	Emergency Battery Back Up, 8W, 90 Minutes
EM15	Emergency Battery Back Up, 15W, 90 Minutes
EM20	Emergency Battery Back Up, 20W, 90 Minutes

* Please contact LITELUME for all Custom Option Requests